



14-2740422-1

## **WITNESSING OF IMPACT LOAD TEST**

On behalf of

**Eye-Catcher Innovations**

21st February 2014



**BUREAU  
VERITAS**

Eye-Catcher Innovations  
Suite 1B, 2 Portrush Road  
Payneham SA 5070

***Move Forward with Confidence***  
Bureau Veritas Asset Integrity and Reliability Services Pty Ltd  
ABN 86 000 928 816  
35-37 Stirling Street  
Thebarton SA 5031 Australia  
Tel: 61 8 8416 500 Fax: 61 8 8234 2760  
Email: [airs@au.bureauveritas.com](mailto:airs@au.bureauveritas.com)

**ATTENTION:**

Mr. Paul Huxtable

**CLIENT REFERENCE:**

Request

**SAMPLE IDENTIFICATION:**

Protect-it 3 plastic column guard

**WORK REQUESTED:**

3<sup>rd</sup> party witness of impact testing of the Protect-it 3 plastic column guard whilst attached to a range of rack profiles

**WITNESSING OFFICER(s):**

Mr Andrew Kramer, Metallurgical Consultant,  
Bureau Veritas











**TESTED BY:**

Eye-Catcher Innovations

## 1. INTRODUCTION

Bureau Veritas witnessed impact testing of the **Protect-it 3 plastic column guard** whilst attached to a range of rack profiles. Testing was carried out at the premises of Compelling Solutions Pty Ltd on Thursday 20<sup>th</sup> February 2014 and was witnessed by Andrew Kramer of Bureau Veritas.

## 2. RESULTS – Table 1

Rack Profile type	Profile Width	Steel Thickness	Front Impact	Side Impact
Generic Profile Dexion Mk3/Universal	80mm(3.15")	1.9mm (0.075")	PASS 	PASS 
Generic Profile Dexion Mk3/Universal	80mm(3.15")	2.2mm (0.087")	PASS 	PASS 
Dexion Mk8 Speedlock 90R Profile	90mm(3.54")	1.6mm (0.063")	PASS 	PASS 
Dexion Mk6 Speedlock 90M Profile	90mm(3.54")	1.9mm (0.075")	PASS 	PASS 
Schaefer Interlock 600 Profile	88mm(3.46")	2mm (0.079")	PASS 	PASS 

## 3. TEST STANDARD

Impact testing was undertaken in accordance with the following racking standards.

Europe - EN 15512-2009, EN 15635-2008, FEM 10.2.10

Australia -AS4082-2012

UK - SEMA

All of the above standards use the following test procedure

### ACCIDENTAL IMPACT LOADS

*"The minimum requirements for the protection of corner uprights shall be as follows:*

*(a) An upright protector with a height of not less than 400 mm (15.75 inches) shall be positioned at the end upright of each run of racking between cross-aisles.*

*(b) An upright protector shall be positioned at all those uprights positioned at aisle and gangway intersections.*

*(c) The upright protector shall be designed for an energy absorption of not less than 400 Nm (3540 pound-force-inches) in any direction at any height between 0.1 m and 0.4 m.*

*(d) The upright protector shall be positioned in such a way that, after its deformation by absorbing an impact, the upright will not be damaged.*

*Uprights other than corner uprights may be protected in a direction normal to the aisle"*

## 4. METHOD for MEASURING DAMAGE

The method for determining "damage" is also specified in all of the aforementioned standards.

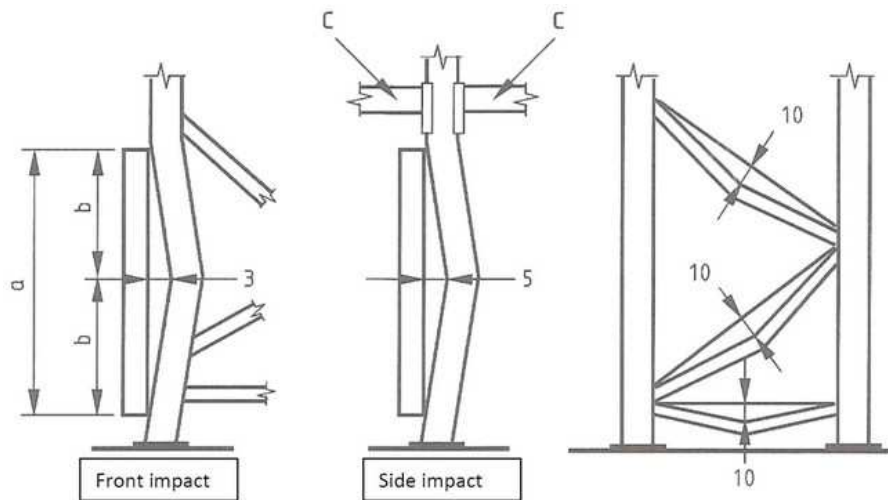

- A 1 metre long straight edge was placed against the corner edges of the impacted face to measure deflection.
- Maximum allowable front deflection at any time was within 3mm (0.118 inches)
- Maximum allowable side deflection at any time was within 5mm (0.197inches)

#### 5. RACK FRAME DETAIL

Testing was carried out using frame assemblies of approximately 1.2 metres(47.25") in length using standard components and profiles, including cross braces, diagonal cross braces, base plates, bolts, nuts and spacers. To facilitate testing the base plates were used at both ends to secure the frame safely.

#### 6. TEST APPARATUS and PROCEDURE

- The test jig consisted of a vertical frame and an impact weight which has an impact footprint of 300mm (11.8") long by 200mm(7.9") wide and weighs 40kg (88.185 pounds)
- The weight was attached to a pulley system to lift the weight.
- Three Protect-it 3 rack guards were installed on each rack assembly delivering 400mm (15.75") of protection to the rack assemblies.
- The weight was then raised 1.02 metres (40.16 inches) above the face of the profile and released to impact the target zone. An impact energy of 400Nm (3540 pound-force-inches) was applied to the to the rack assembly between 100mm (3.94") and 400mm (15.75") above the base plate.

The column assembly was then removed from the jig and inspected for damage the procedure in section 4 (see table 1 on page 3 of 4 for the test results)

#### Reviewed by:



Paul Hosking  
Operations Supervisor  
Material Services

This report was prepared by Bureau Veritas expressly for the customer as nominated on the front cover. Neither Bureau Veritas nor any person acting in its behalf (a) makes any warranty, express or implied, with respect to the use of any information or methods disclosed in this report or (b) assumes any liability with respect to the use of any information or methods disclosed in this report. Any recipient of this document, by their acceptance or use of this document, releases Bureau Veritas and their affiliates from any liability for direct, indirect, consequential or special loss or damage whether arising in contract, warranty, express or implied, tort or otherwise, and irrespective of fault, negligence and strict liability. Email copies of this report are not official unless authenticated and signed by Bureau Veritas and are not to be modified in any manner without the express written consent of Bureau Veritas.

Bureau Veritas AIRS • 35-37 Stirling Street Thebarton SA 5031 • PO Box 338 Torrensville Plaza SA 5031  
ABN 86 000 928 816 • Telephone: +61 8 8416 5337 • Facsimile: +61 8 8234 2760